

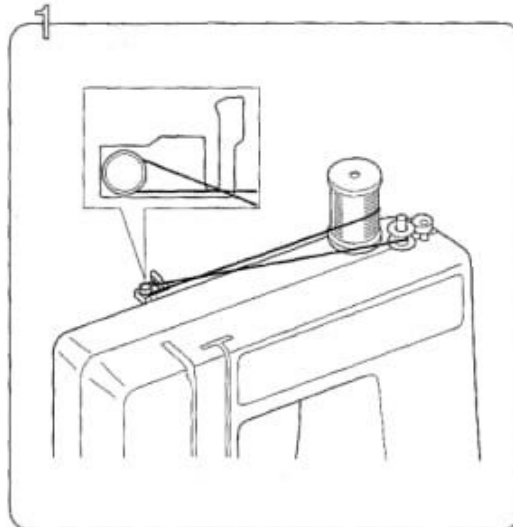

Day 13

Filling the bobbin



Place the thread spool on the spool pin and pass the thread around the bobbin winder thread guide.

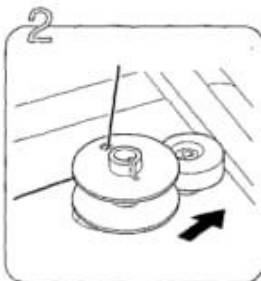

2
Pass the thread through the hole on the bobbin from inside, and slide the winding shaft to the right.



3
While holding the end of the thread, depress the foot controller.

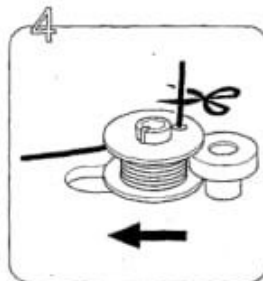

4
When the bobbin is full, it will stop winding. Cut the thread, slide the winding shaft to the left and remove the bobbin.



5
Raise the needle to its highest position and remove the bobbin case by pulling the latch.

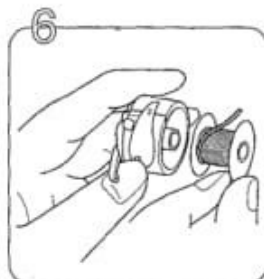

6
Hold the bobbin case as shown, insert the bobbin with the thread coming from the bottom toward the top and the thread tail hanging out of the bobbin case.

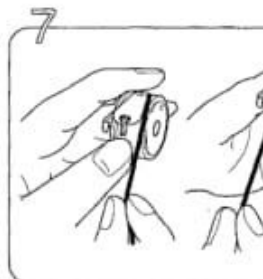

7
Pull the thread tail into the bobbin case groove, under the spring clip and into the thread guide hole.

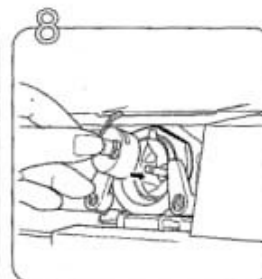

8
Holding the bobbin case by the latch align the finger with the top opening of the shuttle race, insert the case into the shuttle race and release the latch. The latch should hold the bobbin case in place.

B

Day 13

Threading the needle

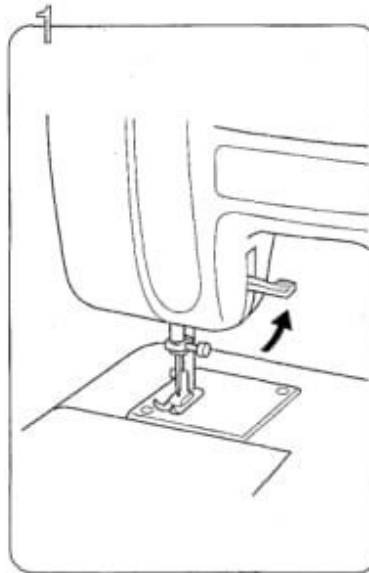
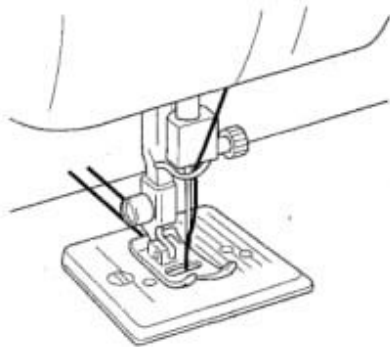

Raise the presser foot lifter.



Raise the thread take-up lever to its highest position by turning the balance hand wheel.

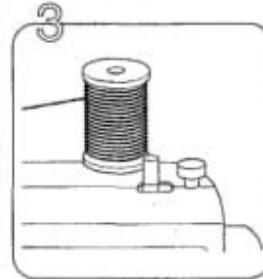

Place the thread spool on the spool pin.

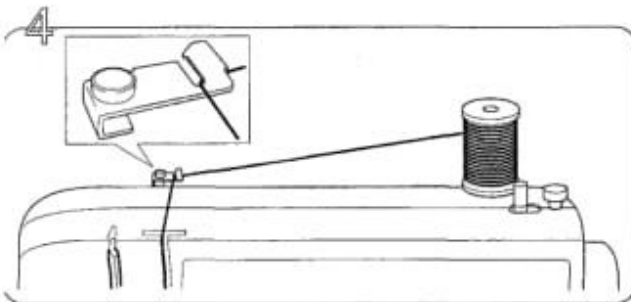

Pass the thread through the thread guide and down the right channel on the front of the machine.

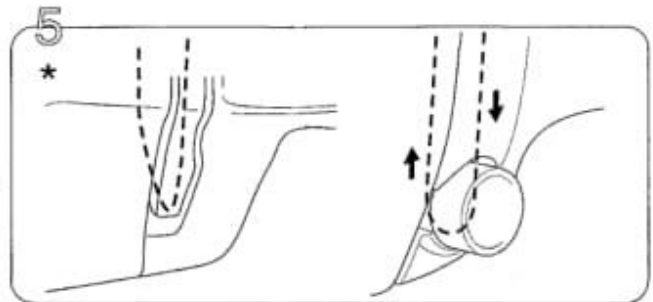

Pass the thread into the thread tension discs or *behind the thread tension dial from the right to the left.

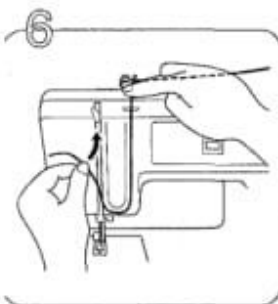

Grasp the thread on both sides of the tension disc and pull to ensure it is in place.

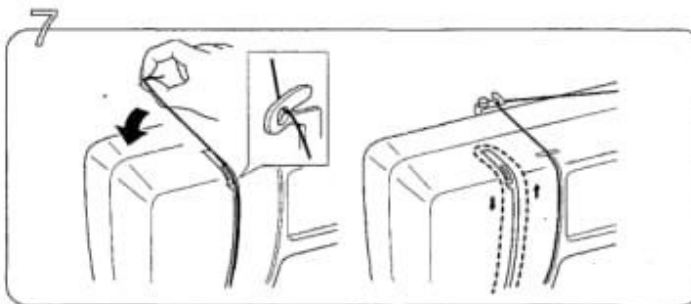

Guide the thread up the left channel, clear to the back of the opening around the take-up lever and back down the left side of the channel to thread the take-up lever.

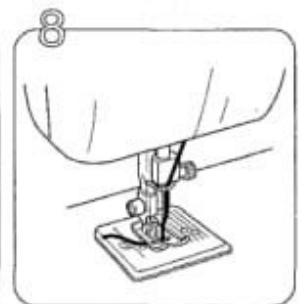

Thread the needle from front to back and pull out about 2" of thread.